

FM 4th generation devices driver registration

Preface

In the Driver registration options you can set one of our prepared driver registration types. Various registration sources are supported. It is possible to set FM device output to give information about registration via LED, Buzzer or even use it to block vehicle ignition.

Registration types:

- Dual registration
- Driver registration
- Mandatory Registration
- Block/unblock

You can get all newest software and firmware at: doc.ruptela.it



Legal notice

Copyright © 2017 Ruptela. All rights reserved. Reproduction, transfer, distribution or storage of parts or all of the contents in this document in any form without the prior written permission of Ruptela is prohibited. Other products and company names mentioned in this document are trademarks or trade names of their respective owners.

Document change log

Date	Version	Change details
2016-12-16	1.5	Initial remake draft.
2017-03-07	1.6	Improvements related to the magnetic card reader support.
2017-03-27	1.7	Improvements related to the iButton DS 1971 EEPROM reading support.
2017-08-22	1.8	Added a "Buzzer/LED alarm when engine is blocked" feature in chapter "Blocking: Deregistration timeout and Reset ID".

Contents

1.	Driver registration and related sections in configurator	3
2.	Wireless ID, card reader or an iButton reader configuration	4
2.1.	iButton / 1-wire RFID configuration	4
2.2.	iButton DS1971 EEPROM reading through 1-Wire interface configuration	5
2.2.1.	iButton DS1971 EEPROM reading IO parameters	6
2.3.	RS232 RFID configuration	6
2.4.	Magnetic card reader configuration.....	7
2.5.	Wireless Driver ID from OnTrack Connect app	8
3.	Configuring DOUTs	10
4.	Authorized IDs list.....	11
5.	Driver registration options	13
5.1.	Registration	14
5.1.1.	Registration: Output.....	14
5.1.2.	Registration: Registration source.....	14
5.1.3.	Registration: Deregistration timeout and Reset ID	14
5.1.4.	Registration: Operation logic.....	14
5.2.	Mandatory registration.....	15
5.2.1.	Mandatory registration: Output.....	15
5.2.2.	Mandatory registration: Registration source.....	15
5.2.3.	Mandatory registration: Only Authorized IDs	15
5.2.4.	Mandatory registration: Deregistration timeout and Reset ID	15
5.2.5.	Mandatory registration: Configurable alert duration	15
5.2.6.	Mandatory registration: Operation logic.....	16
5.3.	Dual registration	17
5.3.1.	Dual registration: Output	17
5.3.2.	Dual registration: Registration source.....	17
5.3.3.	Dual registration: Deregistration timeout and Reset ID	17
5.3.4.	Dual registration: Operation logic.....	17
5.4.	Blocking (Engine lock).....	19
5.4.1.	Blocking: Output	19
5.4.2.	Blocking: Registration source	20
5.4.3.	Blocking: Deregistration timeout and Reset ID.....	20
5.4.4.	Blocking: Operation logic	21
5.5.	Passenger registration	21
5.5.1.	Passenger should stop buzzer	22
5.6.	Indication.....	22
6.	Installation recommendations	24
6.1.	Ignition lock schematics	24
6.2.	iButton and Buzzer/LED connection	24
6.3.	1-Wire RFID reader and buzzer connection	25
6.4.	RS232 RFID reader connection.....	25
6.5.	Magnetic card reader connection	26

1. Driver registration and related sections in configurator

Important sections in FM device configurator that directly influence driver registration options are mentioned below:

1. Start up the FM device configurator. In the **Authorized IDs** section, click the options button. This will open a new window called "Authorized IDs" In this window the user will have to input authorized numbers that will be allowed blocking/unblocking various functions (e.g. ignition). These numbers can be iButton, RFID, Magnetic card IDs or ID from OnTrack Connect smartphone app.
2. In the configurator's main window, locate the **IO events** section and click the options button. This will open a new window called **IO settings**. Here you can configure peripheral devices connected to the DOUTs of the FM device.
3. In the configurator's main window, locate the **Driver registration** section and click the options button. This will open a new window called **Registration settings**. In this window you can change the driver registration settings.

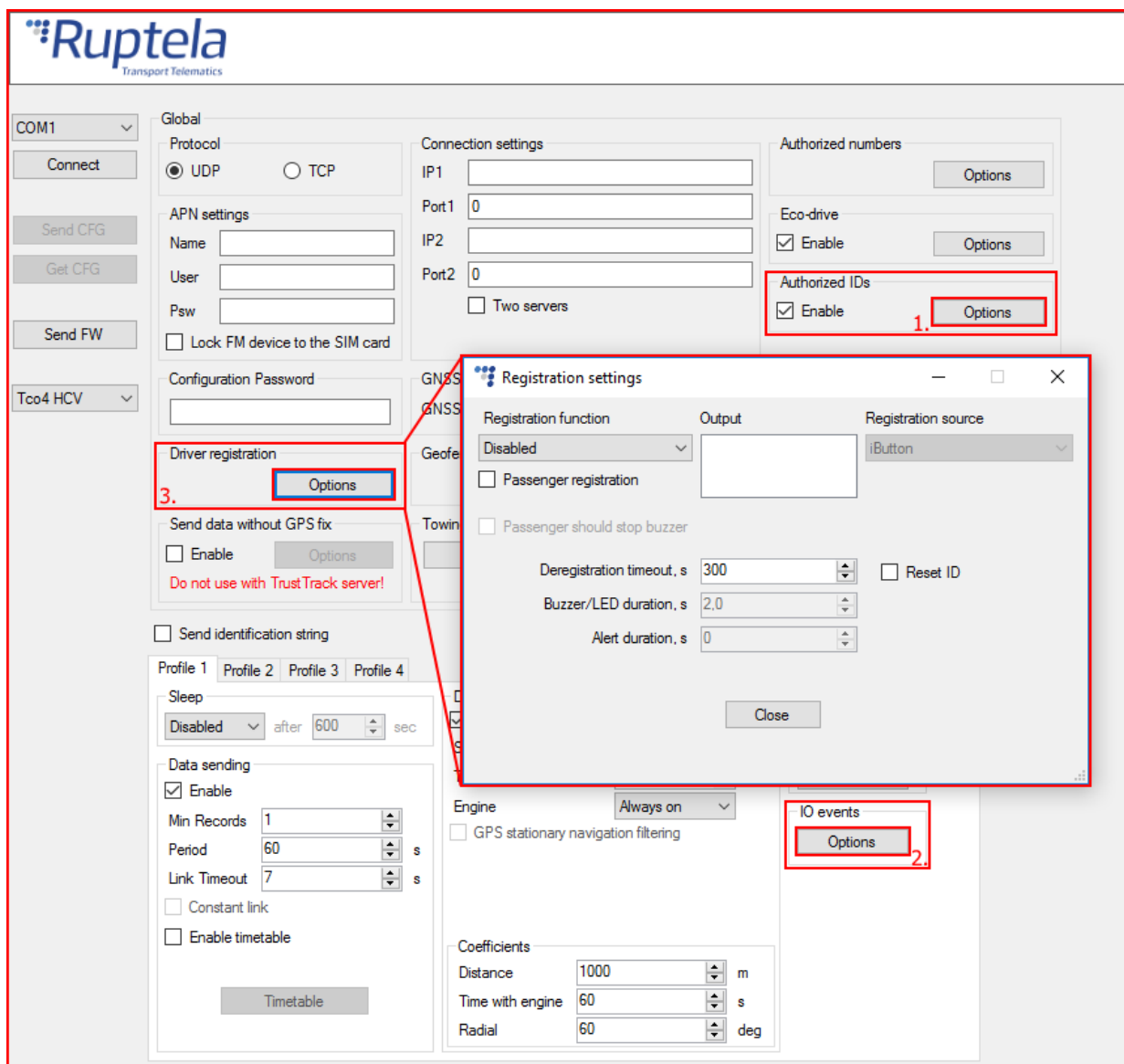

2. Wireless ID, card reader or an iButton reader configuration

2.1. iButton / 1-wire RFID configuration

Note

You must enable IO parameter *iButton ID* to see the ID number in TrustTrack system reports. Configuration is the same for iButton and for 1-wire RFID devices.

1. Open the **IO settings** window as described previously. Select an empty slot in which the newly selected parameter will be set. (Empty slots are marked by "disabled", in the example below the slot is already named after the parameter since, the **Enable** checkbox was already marked).
2. Next, open the **ID** drop down list and select "iButton driver ID".
3. Mark the **Enable** checkbox to activate the parameter, if this checkbox is not marked, then the parameter will not be set in the selected slot.
4. Set **Event on** to *Change*.
5. Set the **Priority** to *High*.
6. Now the parameter is enabled and configured, you can safely close the window or continue enabling and configuring other parameters.

The screenshot shows the 'IO settings' window with the following configuration:

- Slot 1: iButton driver ID (1.)
- IO properties: Enable (3.)
- ID: iButton driver ID (2.)
- Level: 0
- Delta: 0
- Average: 1000 ms
- Event on: Change (4.)
- Include data only on event
- Priority: High (5.)
- Switch to: No Switch
- IO counters: Records on event: 1
- Protocol selection: Send I/O data with v1.1 protocol
- Interfaces: PortA, PortB, PortC, K-Line, CAN, CAN2 (all disabled)
- LCV Autoselect (disabled)
- DOUT1: Disabled
- DOUT2: Disabled

2.2. iButton DS1971 EEPROM reading through 1-Wire interface configuration

This applies for FM-Pro4, FM-Tco4 HCV / HCV BT, FM-Tco4 LCV / LCV BT and FM-Eco4 /Eco4 light devices.

Note

You must enable according IO parameters (8B or 16B) *DS1971 iButton ID* to see the ID number in TrustTrack system reports.

1. In the "IO settings" window navigate to the **Protocol selection** section and put a tick in **Send I/O data with v1.1 protocol** checkbox. After this step, DS1971 iButton IO parameter will be displayed in the IO list.
2. In the Interfaces section, put a tick on the 1-wire checkbox.
3. Use the drop down list on the right and choose *DS1971*. Click the "Config" button to open the DS1971 iButton options.
4. Tick one of the **Data length** radial check boxes and choose how many bytes of data should be read. Default value is 8 bytes. (If offset is used, the device will read bytes that are situated after skipped symbols).
5. Set **Offset** field value. This defines how many starting symbols from the ID should be skipped, when reading the DS1971 iButton. Default offset value is 0 (Value range 0 – 31).
6. In the IO properties section tick the Enable check box, otherwise the slot will remain empty.
7. ID contains the parameters list. Choose a parameter you want to enable for the selected slot. DS1971 iButton requires "DS1971 iButton internal 8B driver ID" or "DS1971 iButton internal 16B driver ID" IO parameter to be enabled. (Parameter name depends on what data length was chosen in 1-wire DS1971 iButton configuration settings).
8. Set **Event on** to *Change*.
9. Set **Priority** to *High*.

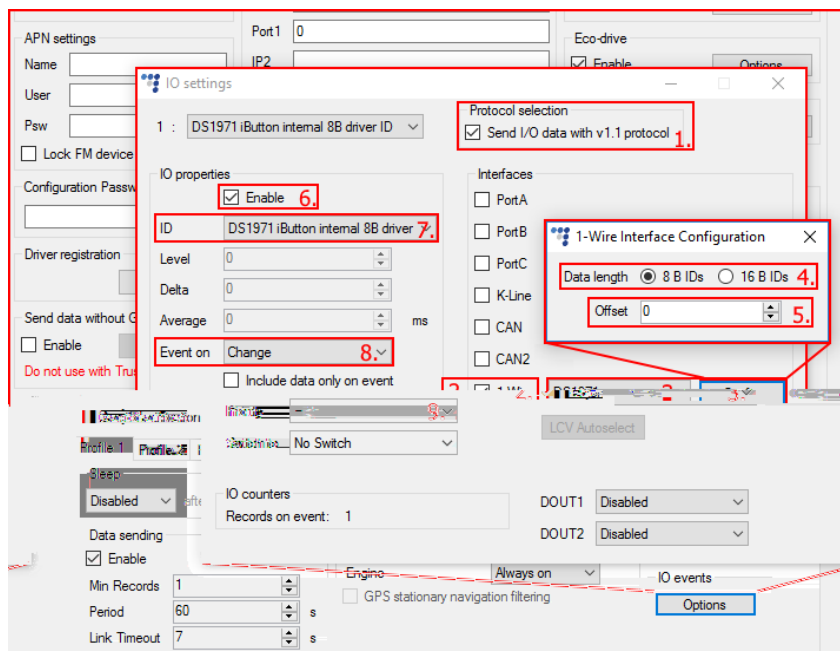

Note

Reading the EEPROM from the DS1971 iButton takes longer than reading a usual iButton, it is highly recommended to hold the iButton a couple of second longer when scanning the DS1971 iButton.

Important!

If DS1971 iButton EEPROM reading is configured on 1-Wire, other 1-Wire peripherals connected to the FM device will not work!

2.2.1. IButton DS1971 EEPROM reading IO parameters

IO parameter "DS1971 iButton internal 16B driver ID" and "DS 1971 iButton internal 16B passenger ID" is comprised of two FM IO parameters. These two I/O's will be pieced together in server side. "DS1971 iButton internal 8B driver ID" and "DS1971 iButton internal 8B passenger ID" have the usual structure.

IO ID	Parameter name in FMIO list	Parameter name in configurator	Size, B	Description
620	DS1971_iButton_internal_8B_driver_ID	DS1971 iButton internal 8B driver ID	8	8 B DS1971 iButton ID
621	DS1971_iButton_internal_16B_driver_ID1	DS1971 iButton internal 16B driver ID	8	First part of 16 B DS1971 iButton ID
622	DS1971_iButton_internal_16B_driver_ID2	DS1971 iButton internal 16B driver ID	8	Second part of 16 B DS1971 iButton ID
623	DS1971_iButton_internal_8B_passenger_ID	DS1971 iButton internal 8B passenger ID	8	8 B DS1971 iButton ID

- In the **Interfaces** section, mark the **PortA** or **PortB** checkbox, this will enable a dropdown list to the right of the checkbox name. In the dropdown list select *RFID reader*.
- Now the parameter is enabled and configured, you can safely close the window or continue enabling and configuring other parameters.

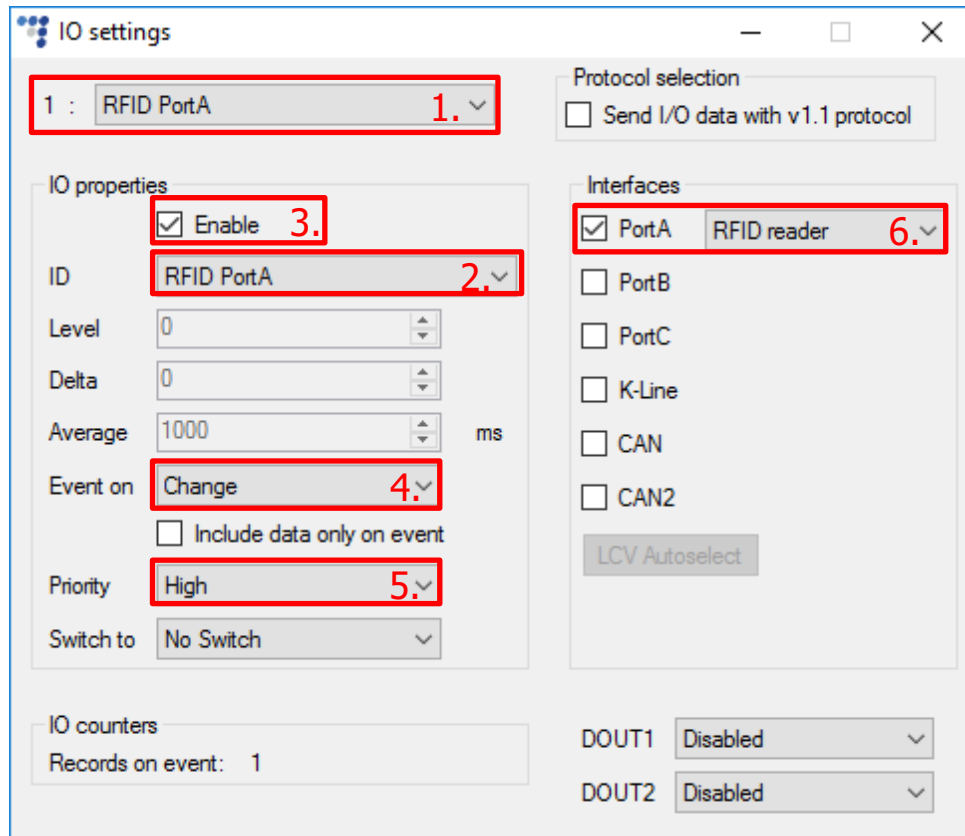

2.4. Magnetic card reader configuration

- In the "IO settings" window navigate to the **Protocol selection** section and put a tick in **Send I/O data with v1.1 protocol** checkbox. After this step, Magnetic card reader IO parameter will be displayed in the IO list.
- In the Interfaces section, put a tick either on **PortA** or **PortB** checkbox. This should be the same FM device interface that was used in connection to the Magnetic card reader.
- Use the drop down list on the right and choose *Magnetic card reader*. Click the "Config" button to view magnetic card reader options. Detailed description can be found in the "Magnetic card reader connection and configuration" document available [here](#).
- Select a slot that you want to enable.
- In the IO properties section tick the Enable check box, otherwise the slot will remain empty.
- ID contains the parameters list. Choose a parameter you want to enable for the selected slot. Magnetic card reader requires "Magnetic card 8 B ID" or "Magnetic card 16 B ID" IO parameter to be enabled. (Parameter name depends on what data length was chosen in magnetic card reader's configuration settings).
- Set **Event on** to *Change*.

- Set the **Priority** to *High*.

The screenshot shows the 'IO settings' window with the following configurations and annotations:

- 1:** Slot 1 is selected with the ID 'Magnetic card 8 B id'.
- 2:** 'PortA' is selected under the 'Interfaces' section.
- 3:** The 'Magnetic card read' dropdown menu is open, and the 'Config' button is highlighted.
- 4:** The 'Send I/O data with v1.1 protocol' checkbox is checked under 'Protocol selection'.
- 5:** The 'Enable' checkbox is checked under 'IO properties'.
- 6:** The 'ID' dropdown menu is set to 'Magnetic card 8 B id'.
- 7:** The 'Event on' dropdown menu is set to 'Change'.
- 8:** The 'Priority' dropdown menu is set to 'High'.

Other visible settings include: Level: 0, Delta: 0, Average: 0 ms, 'Include data only on event' (unchecked), 'Switch to: No Switch', 'IO counters: Records on event: 1', and 'DOUT1' and 'DOUT2' both set to 'Disabled'.

2.5. Wireless Driver ID from OnTrack Connect app

This applies for FM-Pro4 BT, FM-Tco4 HCV BT and FM-Tco4 LCV BT devices.

Note

You must enable IO parameter *Wireless Driver ID* to see the ID number in TrustTrack system reports.

- In the **Protocol selection** section, mark the **Send I/O data with v1.1 protocol**, otherwise the "Wireless Driver ID" parameter will not be displayed in the ID list.
- Open the **IO settings** window as described previously. Select an empty slot in which the newly selected parameter will be set. (Empty slots are marked by "disabled", in the example below the slot is already name after the parameter since, the **Enable** checkbox was already marked).
- Next, open the **ID** drop down list and select *Wireless Driver ID*.

4. Mark the **Enable** checkbox to activate the parameter, if this checkbox is not marked, then the parameter will not be set in the selected slot.
5. Set **Event on** to *Change*.
6. Set the **Priority** to *High*.
7. Now the parameter is enabled and configured, you can safely close the window or continue enabling and configuring other parameters.

The screenshot shows the 'IO settings' window with the following configuration:

- 1 :** Wireless Driver ID
- Protocol selection:** Send I/O data with v1.1 protocol
- IO properties:**
 - Enable
 - ID:** Wireless Driver ID (4)
 - Level:** 0
 - Delta:** 0
 - Average:** 0 ms
 - Event on:** Change (5)
 - Include data only on event
 - Priority:** High (6)
 - Switch to:** No Switch
- Interfaces:**
 - PortA
 - PortB
 - PortC
 - K-Line
 - CAN
 - CAN2
 - LCV Autoselect
- IO counters:** Records on event: 1
- DOUT1:** Disabled
- DOUT2:** Disabled

3. Configuring DOUTs

To configure DOUTs, go to the **IO settings** window as described in the beginning of this document. Each DOUT is configured independently. DOUTs can control peripheral devices and/or ignition blocking function connected to a DOUT. Driver registration can be combined with these four options:

- Disabled;
- LED;
- Buzzer;
- Blocking.

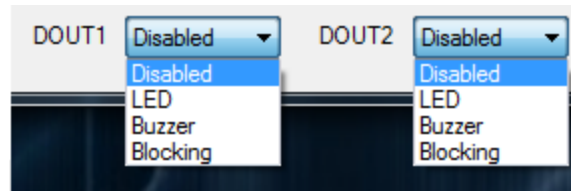

If you select one option on DOUT1 it becomes unavailable on DOUT2 and vice versa.

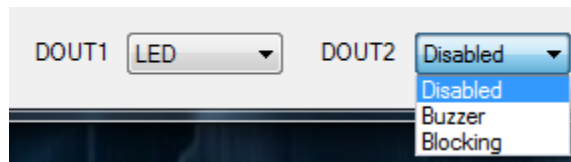

Parameter description:

- Disabled – output will not interact with any peripheral connected;
- LED – will blink when record is made (e.g. card or iButton is read).
- Buzzer – interacts same as LED, just instead of blinking, it will make a sound.
- Blocking – feature will lock ignition until registration is made with authorized iButton, RFID card, Magnetic card or OnTrack Connect app. These features will be discussed further in section Blocking.

Note

You must connect peripheral to DOUT and configure it on that output. E.g. If you connected Buzzer to DOUT1, in configurator, select Buzzer on DOUT1 drop menu.

4. Authorized IDs list

Authorized IDs list can be found in the main configurator's window. Several driver registration modes requires this list.

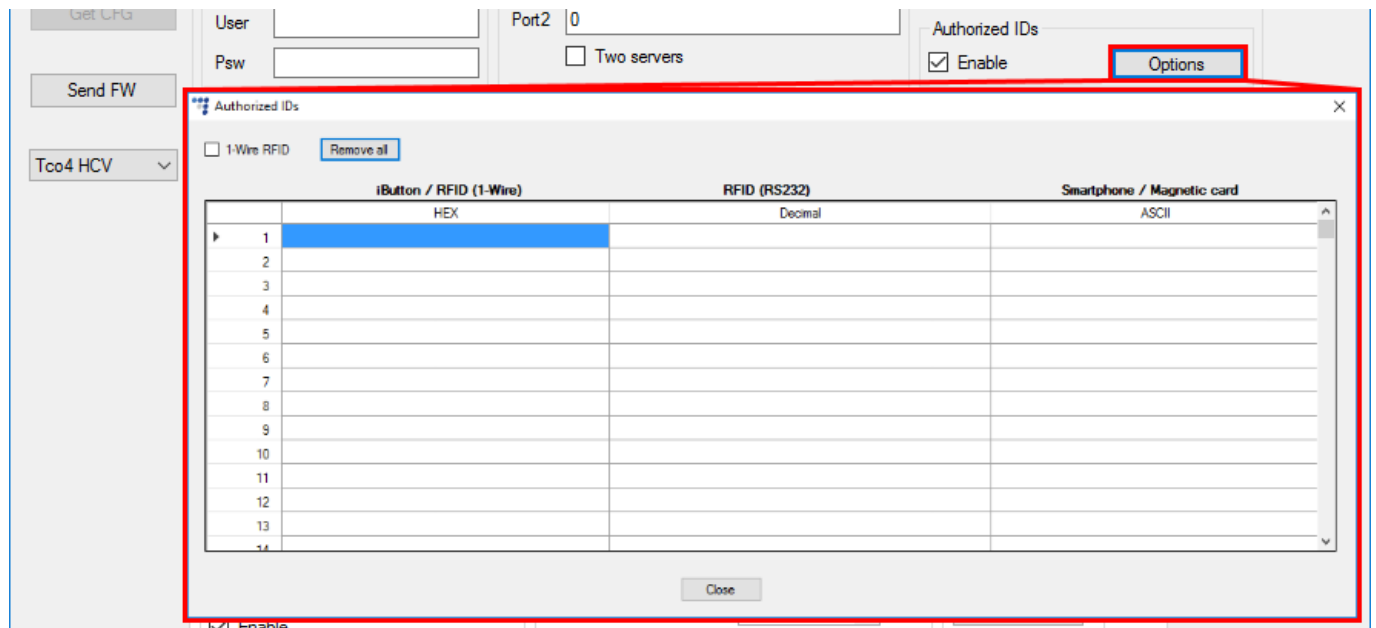

Here you can enter RFID, Magnetic card ID/iButton ID/Wireless Driver ID from OnTrack app, which are allowed to unblock a vehicle or register, when only authorized IDs are accepted. You can store up to 250 16 B IDs or up to 500 8 B IDs in this list.

Note

Authorized IDs list length depends on FM device configuration. If magnetic card reader is configured on one of the RS232 ports and it is prepared to read 16 B IDs, then this list will be able to store up to 250 entries.

List is divided into three columns. ID can be entered in any row and any column. Each column will contain the same ID number represented in "HEX", "Decimal" and "ASCII" formats. It doesn't matter, which column is used, the remaining two fields in the same row will be filled automatically.

Rules:

- "HEX" field allows numbers **0 – 9**, capital letters **A – F** and * (asterisk symbol - wildcard). One asterisk symbol masks 4 bits of data;
- "Decimal" field allows numbers from **0 - 9**;
- "ASCII" field allows any printable ASCII symbols. When * (asterisk symbol - wildcard) is used, it masks 1 byte of data.
- Default size of all fields is 8 bytes. When data length in magnetic card reader options is set to 16 bytes, field size is 16 bytes;
- If the user enters shorter ID's (less than 8 bytes or depending on configuration less than 16 bytes) into the decimal or ASCII cell, empty bytes in the hexadecimal representation are filled with zeros.

5. Driver registration options

After configuring the DOUTs, return to the main configurator window, locate the **Driver registration** section and click the option button this will open a new window called **Registration settings**. At the top left side of the window, locate the **Registration function**. The following functions can be chosen in the dropdown list:

- Disabled;
- Registration;
- Mandatory registration;
- Dual registration

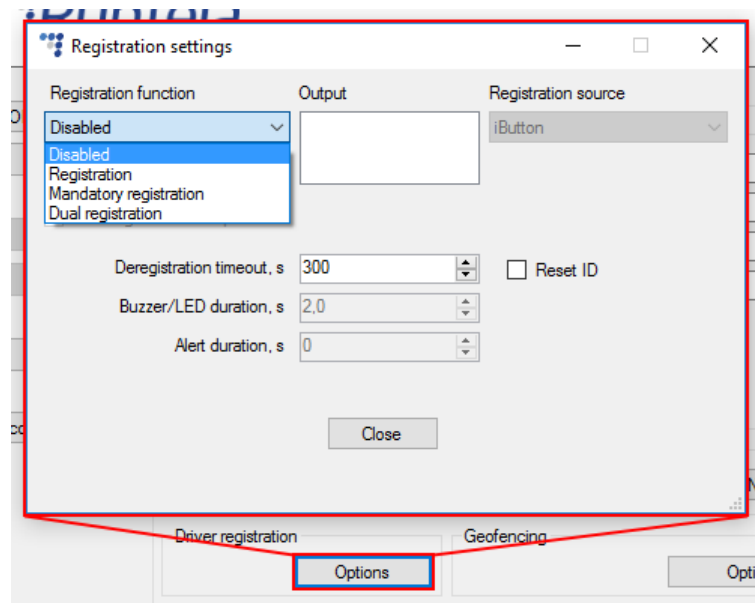

Indication

You can use **Buzzer/LED duration** and **Alert duration** fields to configure various indication aspects. Field effects and various indication rules are described in the "Indication" chapter.

Important!

If you leave the **Registration function** drop down menu as disabled, digital outputs will do nothing and the ID is sent only once (ID is not held until the ignition is switched off).

Passenger registration

All registration modes except dual registration can be combined with Passenger registration option. More details about this can be found in "Passenger registration" chapter.

5.1. Registration

Registration option allows optional driver registration over an iButton or Magnetic card identification sources.

5.1.1. Registration: Output

In the **Output** selection field the user can select peripherals that were previously configured on the DOUTs (LED/Buzzer).

Please note that if you select Registration or Mandatory registration mode and choose Blocking output (if it is configured on DOUTs) engine will not be blocked. Blocking function works ONLY when Registration source: Blocking is selected first.

5.1.2. Registration: Registration source

Since this is an optional registration mode all IDs from all sources are accepted. There is no need to select anything, selection menu is greyed out.

5.1.3. Registration: Deregistration timeout and Reset ID

"Deregistration timeout, s" is a period of time, during which you can start engine again without the need to re-register. For example, deregistration is set to 300 seconds (5 minutes), after a successful registration the user decided to turn the engine off. Now the user still has a possibility to start it again within 5 minutes, this can be done without registration.

If Reset ID checkbox is not checked, ID will be included with every record until deregistration time expires. If it is checked, ID will be sent only when iButton or magnetic card is attached.

Registration function	Output	Registration source
Registration		iButton
<input type="checkbox"/> Passenger registration		<input type="checkbox"/> Only Authorized IDs
<input type="checkbox"/> Passenger should stop buzzer		
Deregistration timeout, s	300	<input type="checkbox"/> Reset ID

5.1.4. Registration: Operation logic

Logical scheme of how registration mode works:

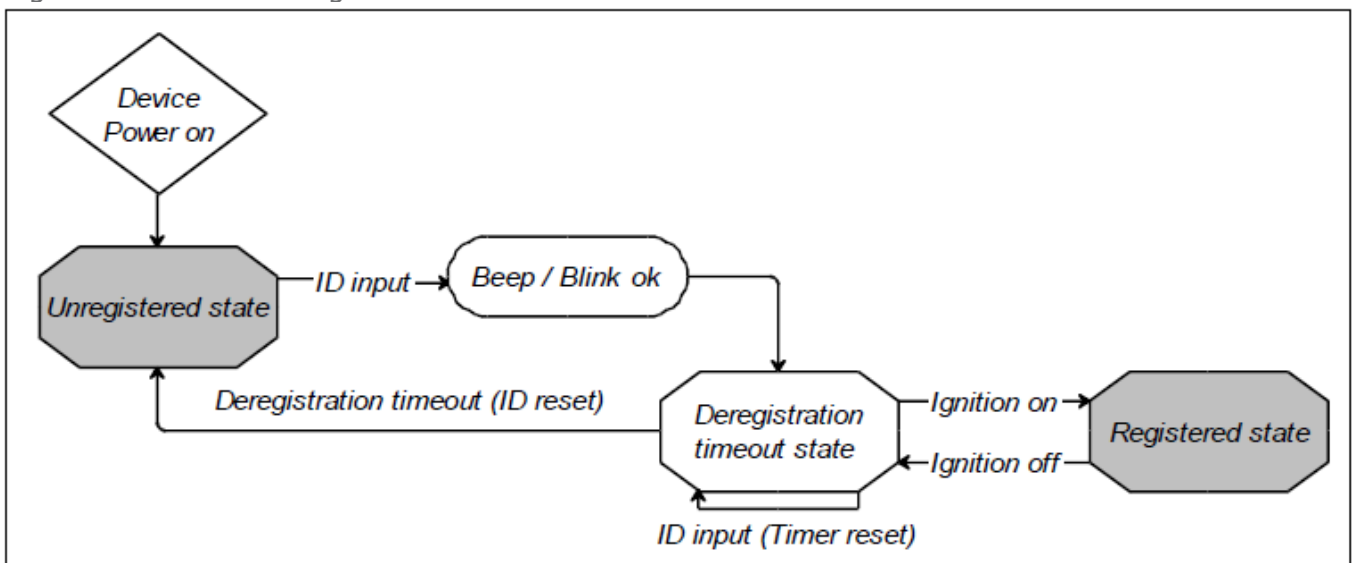

5.2. Mandatory registration

Mandatory registration is designed to "force" driver to register. If vehicle's ignition is on, driver will be constantly reminded to register.

5.2.1. Mandatory registration: Output

In the **Output** selection field the user can select peripherals that were previously configured on the DOUTs (LED/Buzzer).

Please note that if you select Registration or Mandatory registration mode and choose Blocking output (if it is configured on DOUTs), engine will not be blocked. Blocking function works ONLY when Registration source: Blocking is selected first.

5.2.2. Mandatory registration: Registration source

Choose device that reads the driver's ID. For Pro family devices an iButton, iButton DS1971, RFIDs, magnetic card or Smartphone can be used as a mandatory registration source. For Eco family – iButton and iButton DS1971 1-wire RFID only.

Note

"Smartphone" registration function is available only for the FM devices with Bluetooth module. Also, Bluetooth connectivity option has to be enabled in the configurator.

5.2.3. Mandatory registration: Only Authorized IDs

This option can be activated only together with "Mandatory registration" mode. If option is enabled, FM device accepts driver registrations with authorized IDs that are currently present in Authorized IDs list. Driver registrations with other IDs are not allowed.

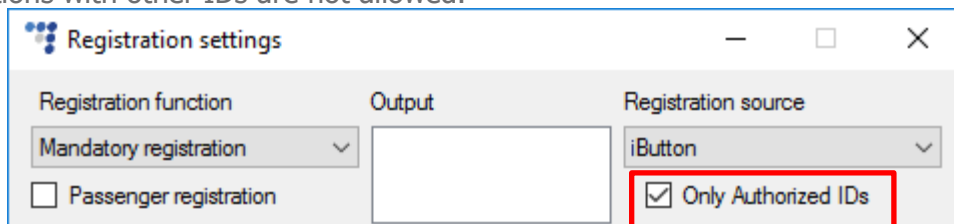

The screenshot shows a window titled "Registration settings" with three main sections: "Registration function", "Output", and "Registration source". Under "Registration function", there is a dropdown menu set to "Mandatory registration" and an unchecked checkbox for "Passenger registration". The "Output" section is currently empty. Under "Registration source", there is a dropdown menu set to "iButton" and a checked checkbox for "Only Authorized IDs", which is highlighted with a red rectangular box.

Note

Only Authorized IDs option is used to crosscheck driver IDs. Passenger IDs are not checked and not limited by this option.

5.2.4. Mandatory registration: Deregistration timeout and Reset ID

Deregistration timeout and Reset ID function the same way as described in "Registration" chapter.

5.2.5. Mandatory registration: Configurable alert duration

If the driver is not identified within 5 seconds after starting the engine, he can still drive, but peripherals connected to the DOUTs will start to indicate: LED will glow and Buzzer will make sound until registration is made or until engine is turned off.

Alert duration

Indication duration can be configured in "Alert duration, s" field. Field is active only when mandatory registration mode is used. Values from 0 to 3600 seconds can be entered. Default value is 0 seconds and it means that indication duration is unlimited.

Alert duration can be used together with an IO ID 537 "Registration alert". This IO can have two values: 0 - no alarm, 1 - registration alert. To enable this IO you must use extended protocol v1.1 version. When enabled, this IO changes its state to 1, if driver or passenger did not register, while engine is on. If buzzer alert duration is configured, then IO should switch to 1 only after configured time period have passed.

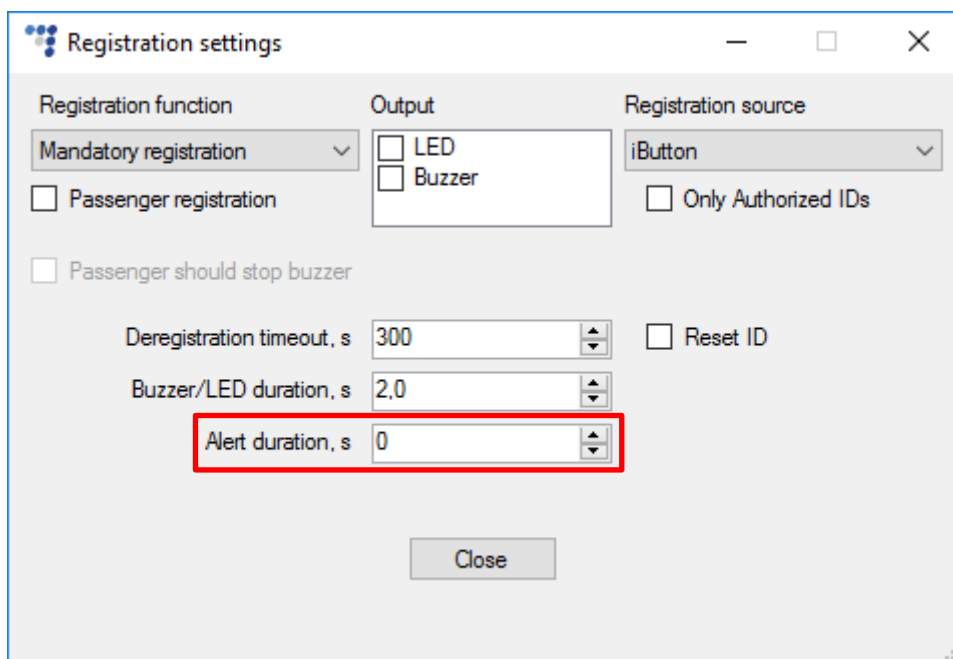

5.2.6. Mandatory registration: Operation logic

Logic scheme how mandatory registration works:

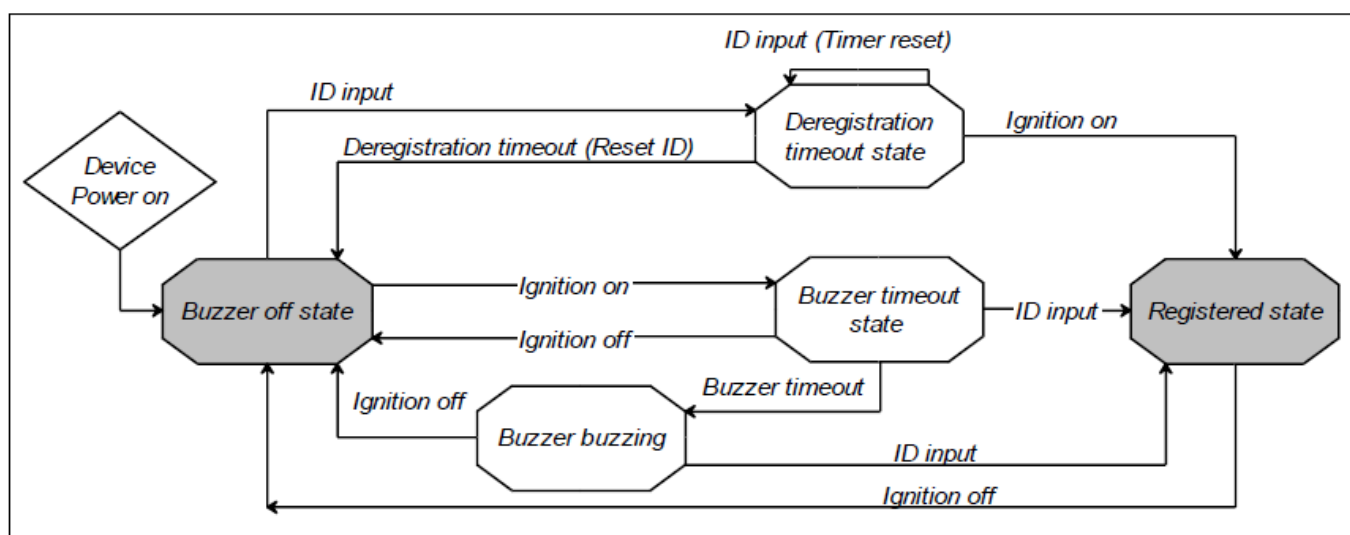

Note

Device will register driver ID with engine off if it is in normal mode or sleep mode. If device is in deep Sleep mode, registration will not happen. Entering sleep and deep sleep modes depend on FM devices configuration. It is recommended to start the engine and afterwards register within 5 seconds.

5.3. Dual registration

Dual registration requires two separate registrations to happen in order to drive the vehicle. Registrations are mandatory. For example, this registration function could come in handy in a driving school, where an instructor and a student would have to register before they could start a driving lesson.

Dual registration is supposed to be used with:

- iButton/ iButton DS1971 / 1-Wire RFID reader – for registration;
- Relay - to block/unblock engines starter;
- Buzzer / LED – for indication.

In dual registration mode, you can also track trip progress. Enable IO ID 583 "Trip Status". To do so you must use extended protocol v1.1 version. IO can generate events on Monitoring, Change. Averaging does not work. Trip status IO can have one of these values:

- 0 – end of the trip;
- 1 - Start of the rout;
- 2 - Open trip;
- 3 - Registration is not done, but car is moving.

5.3.1. Dual registration: Output

In Output selection field you can select peripherals that you configured on the DOUTs (LED/Buzzer).

5.3.2. Dual registration: Registration source

iButton, iButton DS1971 or 1 wire RFID can be used as a dual registration source. Selection menu is greyed out.

Note

During registration process, if EEPROM reading was configured to read from iButton DS1971 on 1-Wire, no other 1-Wire peripherals will work, so it is mandatory to use iButton DS1971 for the second registration.

5.3.3. Dual registration: Deregistration timeout and Reset ID

Deregistration timeout and Reset ID function the same way as described in "Registration" chapter.

5.3.4. Dual registration: Operation logic

Dual registration with buzzer and ignition relay works as follows:

- Vehicle's engine will not start unless dual registration is complete. The device requires two ID reads (from the same card or from two different cards) before enabling the engine's starter. Registration procedure can be started only if the ignition is on.
- The first iButton/card used must be authorized. Its ID has to be entered in Authorized IDs list. Maximum number of IDs is 500. 1-Wire RFID users might also need to enable 1-wire RFID check box in the Authorized ID settings window. This was described in the "Authorized IDs list" chapter.
- If the first iButton/card is authorized, the buzzer (continuing sound) will be enabled to inform the driver to pass the second identification iButton/card (or the same iButton/card once again). At

the same time, the first message is transmitted to the server signaling the "start of the route". If this second iButton/card is not read within 10 seconds, the identification process is reset and a message is sent to the server signaling the "end of the route" (to determine the beginning and end of trip). In this case deregistration timeout is constant and equal to 10 seconds. After this time out, registration procedure must be restarted from the beginning.

- If the second iButton/card is read, the buzzer is disabled and the engine's starter is unblocked. Second message is sent to the server with the ID and trip status changes to "open trip".
- If non-authorized card will be used two times for registration, dual registration will not be done. Engine's starter will be blocked.
- After completed registration, the driver may or may not start the engine, but trip type will be considered as an "open trip". The device must periodically transmit messages according to the time period specified in the configurator tool, until the ignition is detected as being OFF.
- If ignition is turned off, FM device waits for deregistration timeout to occur. Timeout period is configurable via Deregistration timeout, s field. During timeout period, while device is waiting, you can turn on the Ignition and restart the engine without the need to register again. This is useful if engine in the vehicle turned off accidentally.
- If ignition is turned off, and timeout period expires, then FM device sends message to the server signaling the "end of the trip" and resetting the identification process. At this point server can start analyzing trip data. Engine starter is blocked and the only way to turn it ON again is to complete dual registration process.
- If the car is moving (velocity > 10Km/h) with engine on, but there was no registration, the buzzer continuously beeps until the registration is complete. At the same time FM device periodically transmits messages according to its configuration. The source to calculate vehicle's velocity is selected automatically. If FMS/LCV is configured, speed is calculated from CAN data. If FMS/LCV is not configured, data source will be GPS.

All points listed above can be summarized into 3 main cases:

1. Registration and vehicle's engine is turned on in a correct way.

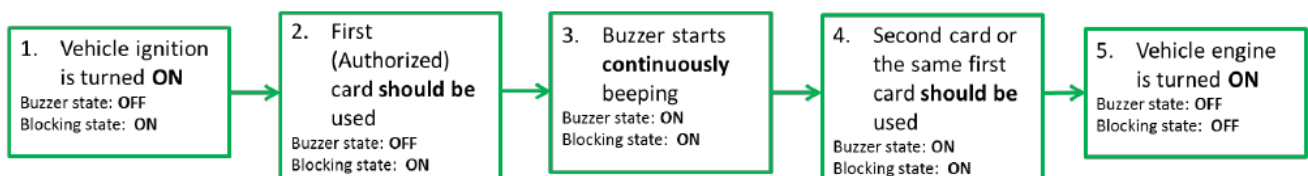

2. Registration and vehicle's engine is turned on in a correct way, but with some boundary conditions.

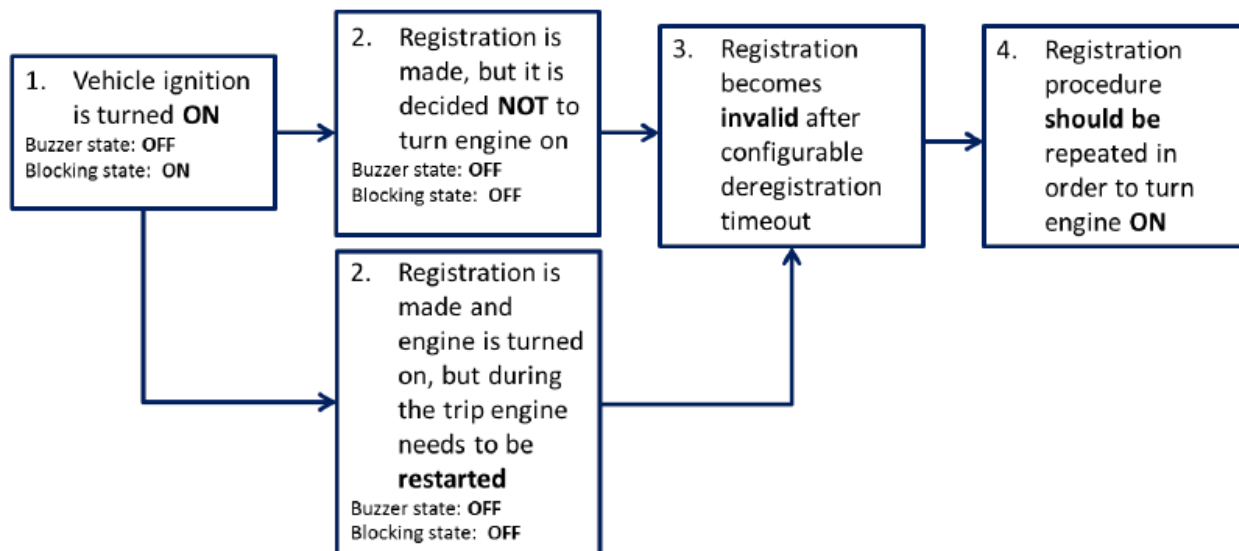

3. Registration and vehicle engine is turned on improperly.

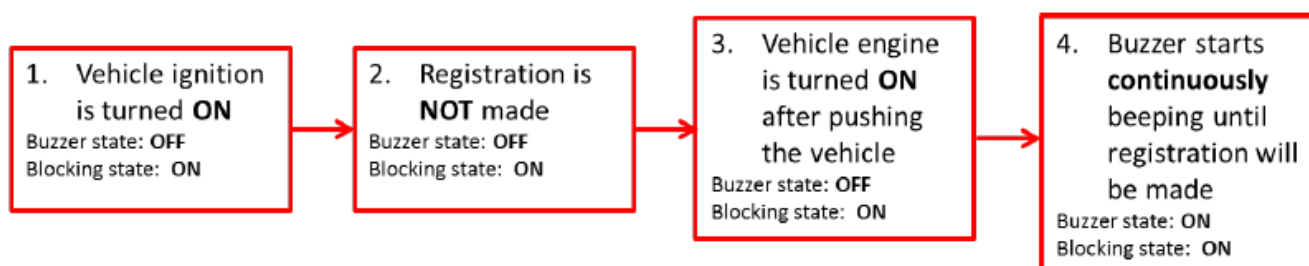

5.4. Blocking (Engine lock)

If you do not need authorized IDs list, you can deselect *Enable* checkbox for the Authorized IDs list - in this case any iButton/RFID card can unlock engine - authorized IDs list is disabled.

Go to **IO events** settings and select *Blocking* on one of DOUTs.

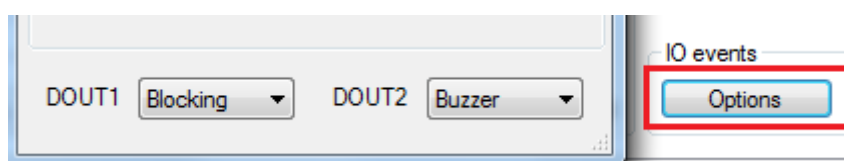

5.4.1. Blocking: Output

Now, go to **Driver registration** in main configurator window. Choose **Registration function** as *Blocking*. On **Output** select *Blocking* (if you do not select it, blocking will not work). If you configured LED/buzzer in the DOUTs section, select it in the Output field. LED will blink/Buzzer will make sound upon successful/unsuccessful registration.

In the drop down list on the right, choose one of the Registration sources.

Note

“Smartphone” registration function is available only for the FM device with Bluetooth module. Also, Bluetooth connectivity option has to be enabled in the configurator.

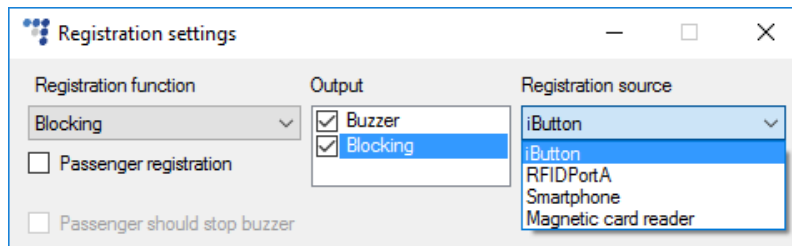

Note

If an authorized ID was used to start engine and then an unauthorized ID was scanned, the record is made with this unauthorized ID, but the ignition is NOT blocked.

5.4.2. Blocking: Registration source

Choose device that reads the driver's ID. For Pro family devices an iButton, DS1971 iButton, RFID, magnetic card readers or Smartphone can be used as a registration source. For Eco family – iButton and 1 Wire RFID only.

5.4.3. Blocking: Deregistration timeout and Reset ID

Deregistration timeout and Reset ID function the same way as described in the “Registration” chapter. It is also possible to enable a Buzzer/LED alarm to alert the driver in case the engine is blocked. This can be done by checking the “**Buzzer/LED alarm when engine is blocked**” box. If a driver is not registered (Deregistration timeout is not in progress) and the driver turns on the ignition, the alarm will go off. The alarm will be switched off once registration is complete. This function is only available when **Registration function** is set to *Blocking*.

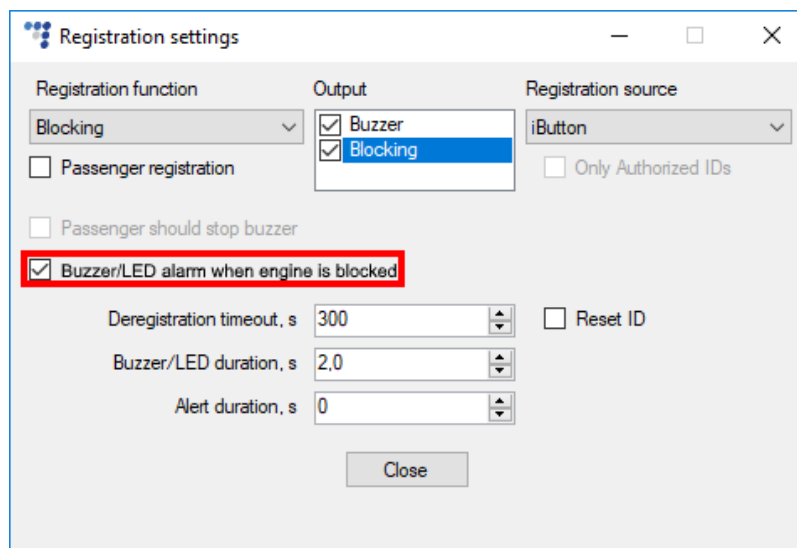

Note

The Buzzer/LED alarm is currently compatible only with the Tco4 HCV, Tco4 LCV and Pro4 series devices.

5.4.4. Blocking: Operation logic

Logic scheme how Blocking works:

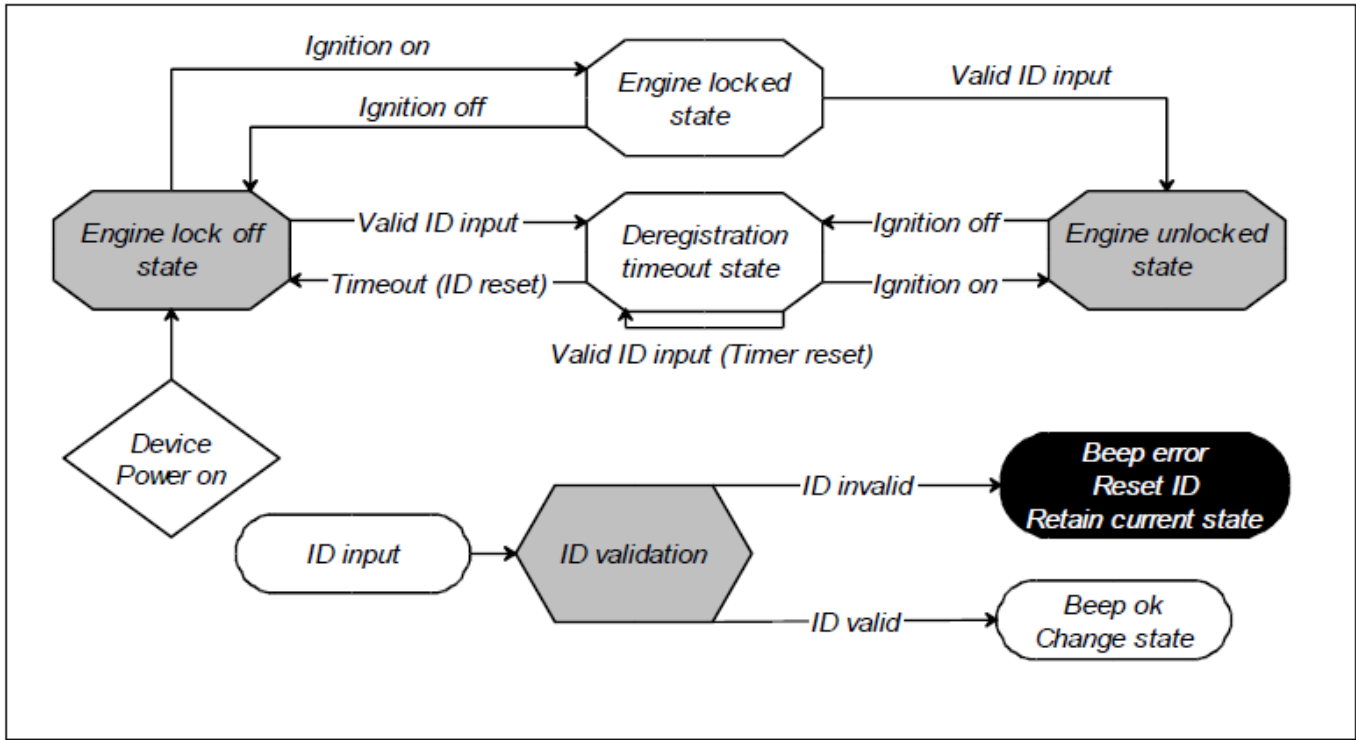

5.5. Passenger registration

This check box allows passengers to register with an iButton/DS1971 iButton or 1 Wire RFID. Feature works with all registration modes except dual registration. Passenger registration requires one of the following:

- IO ID 536 "iButton passenger ID"
- IO ID 623 "DS1971 iButton internal 8B passenger ID"
- IO ID 624 "DS1971 iButton internal 16B passenger ID"

Note

It is important to select the IO ID in accordance to the selected data length (8B or 16B). Information will be read based on that configuration.

To enable one of these IO you must use extended protocol v1.1 version.

iButton IO can generate records with events on Monitoring, Change and Hysteresis. Averaging does not work.

When iButton ID is read and DIN3=0, ID will be written to IO ID 34 (iButton ID).

When iButton ID is read and DIN3=1, ID will be written to IO ID 536 (iButton passenger ID)

iButton DS1971 can generate records with events on Monitoring or Change. Averaging is not available.

When DS1971 iButton ID is read and DIN3=0, ID will be written to IO ID 620 (DS1971 iButton internal 8B driver ID) or to IO ID 621 (DS1971 iButton internal 16B driver ID) – depends on the data length configuration .

When DS1971 iButton ID is read and DIN3=1, ID will be written to IO ID 623 (DS1971 iButton internal 8B passenger ID) or to IO ID 624 (DS1971 iButton internal 16B passenger ID) – depends on the data length configuration .

DIN3 IO enabling is not mandatory.

iButton passenger ID IO is reset together with Driver ID (IO 34) (Same for the DS1971 iButton IO) according to the device configuration. Passenger ID is not verified with authorized ID list, it does not unblock engine for blocking mode and normally it does not disable buzzer/LED for mandatory registration.

5.5.1. Passenger should stop buzzer

In mandatory registration mode, this check box allows passengers to stop buzzer indication after they have successfully registered.

The screenshot shows a 'Registration settings' dialog box with the following configuration:

- Registration function: Mandatory registration
- Output: Buzzer (unchecked), Blocking (unchecked)
- Registration source: iButton
- Passenger registration: (highlighted with a red box)
- * DIN3 connection is required
- Passenger should stop buzzer:
- Deregistration timeout, s: 300
- Buzzer/LED duration, s: 1,5
- Alert duration, s: 0
- Reset ID:

5.6. Indication

- **Buzzer/LED duration, s** - After registration buzzer or LED will indicate for a certain time period. Indication duration is configurable. It can be set in "Buzzer/LED duration, s" field. It can last from 0,1 s to 25 s (min step size is 0,1 s). Default Buzzer duration time is 1,5 s. (This works in all modes except "Dual registration").
- **Alert duration, s** - Field is active when mandatory registration or blocking mode is used. Here you can set how long the buzzer/LED will indicate, while trying to "force" driver to register.

Values from 0 to 3600 seconds can be entered. Default value is 0 seconds and it means that indication duration is unlimited (until a successful registration has passed).

The screenshot shows a 'Registration settings' window with the following configuration:

- Registration function: Mandatory registration
- Output: LED, Buzzer
- Registration source: iButton
- Passenger registration
- Passenger should stop buzzer
- Deregistration timeout, s: 300
- Only Authorized IDs
- Reset ID
- Buzzer/LED duration, s: 2.0 (highlighted in red)
- Alert duration, s: 0 (highlighted in red)

Indication examples:

- In Mandatory registration mode, if driver is not identified in 5 seconds after starting the engine, peripherals connected to the DOUTs will start to indicate. After first successful registration peripherals will immediately stop indicating.
- If there is a second successful registration, peripherals connected to the DOUTs will indicate again (LED will glow and Buzzer will make sound). Indication duration is set in "Buzzer duration, s" field.
- If registration has failed, buzzer/LED will make only few short indications.

Indication in other cases:

- If registration function is set to Registration, peripherals connected to the DOUTs will indicate after each successful registration. Indication duration is set in "Buzzer duration, s" field.
- If registration has failed, buzzer/LED will make only few short indications.

6. Installation recommendations

6.1. Ignition lock schematics

When connected as shown below, device disables engine starter when output is ON. A simple automotive relay is used to invert signal or immobilize engine starter. Note that 12 V and 24 V options are available.

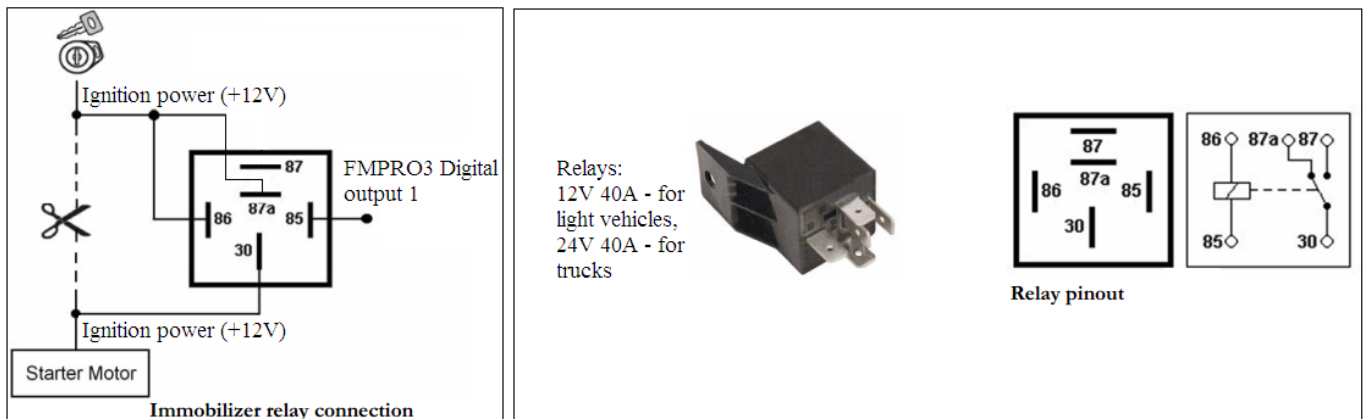

6.2. iButton and Buzzer/LED connection

iButton connection scheme is valid only for iButton (and socket) purchased from Ruptela. If you bought iButton socket elsewhere please see your product datasheet for proper connection. It may require power supply Connection from 1-Wire power terminal (5 Volts).

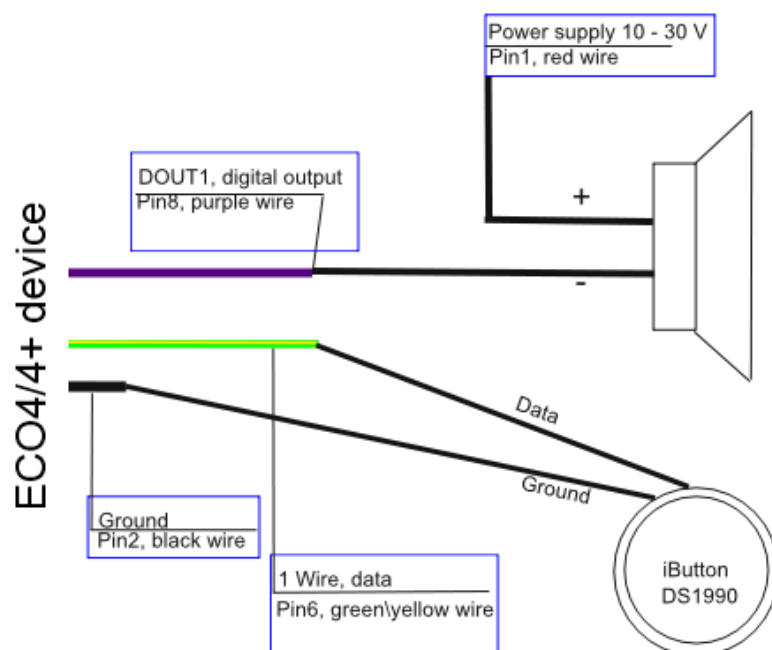

6.3. 1-Wire RFID reader and buzzer connection

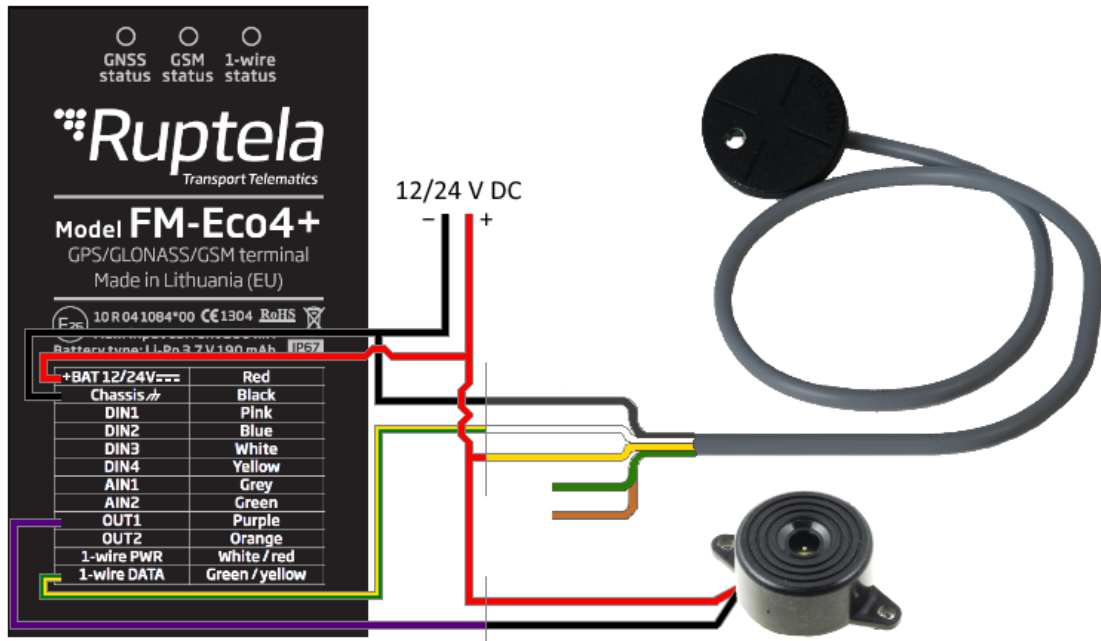

6.4. RS232 RFID reader connection

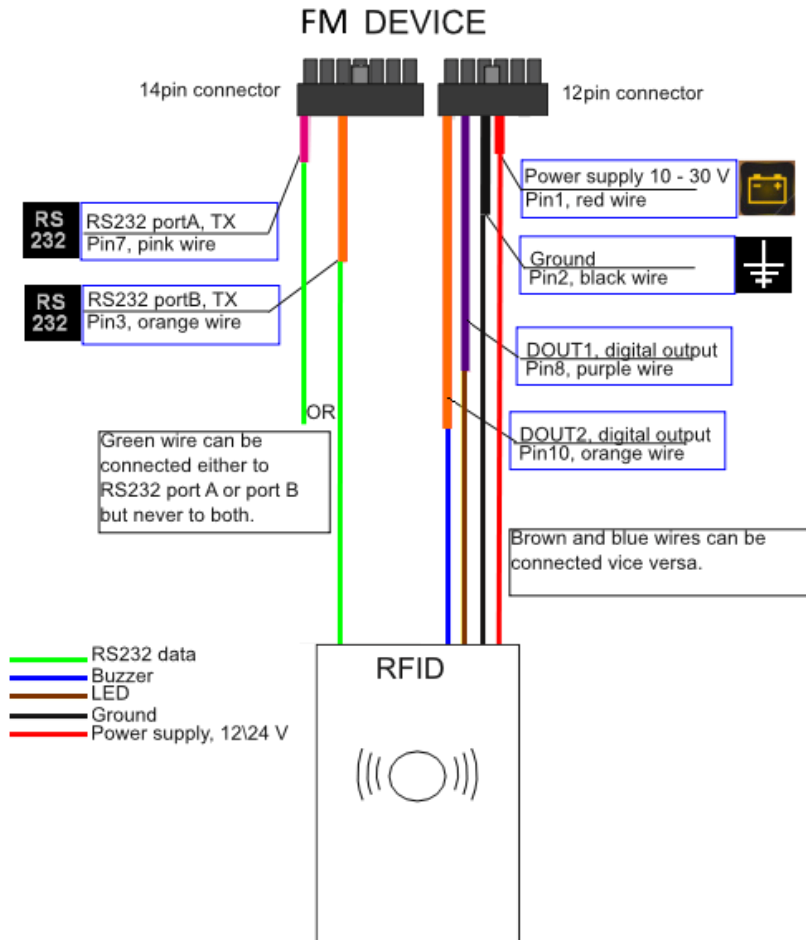

6.5. Magnetic card reader connection

